

Article number: 20241035610

Description: E+G Telescope-Lear motion bearings GN 2410-35-610

Measures

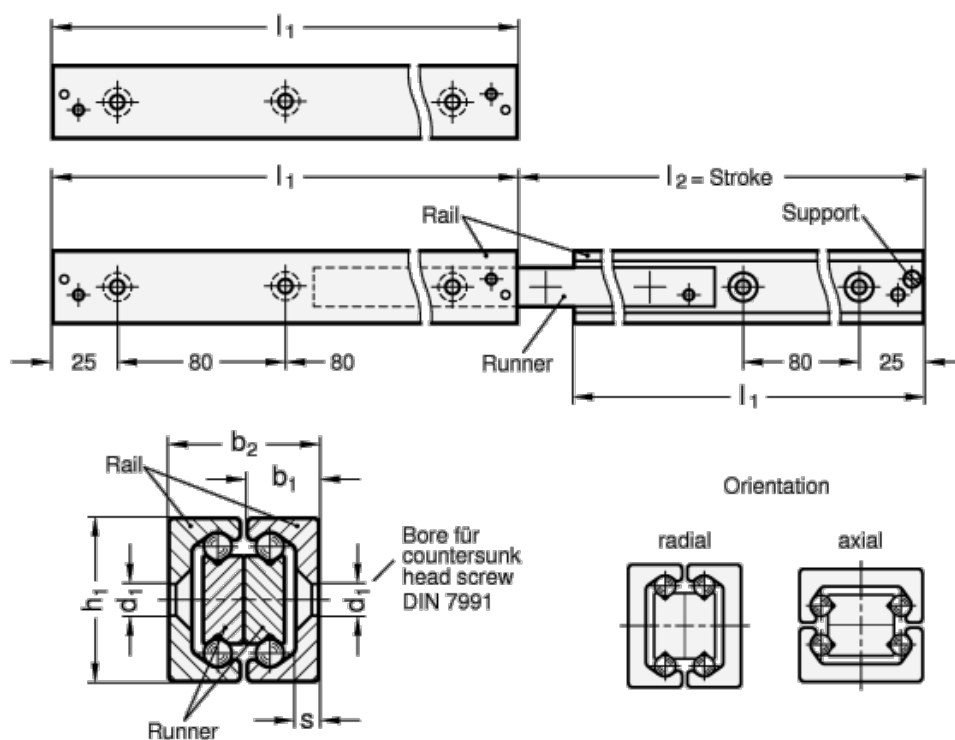

b1	= 16.5
b2	= 34
d1	= M6
d2	= 6.5
h1	= 35
L1	= 610 - 646
s	= 3.5
Weight in (g)	= 3843